

# FRM5 RELAY



## FEATURES

Small size, high capacity  
Easy mounting and wiring  
Simple operation  
Wide variety

FRM5N with built-in operation indicator  
(Mechanical, LED)

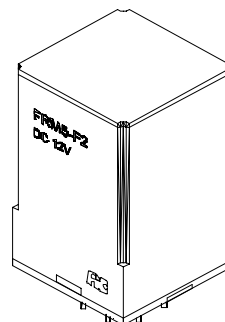

## SPECIFICATIONS

### COIL RATING

RATED VOLTAGE (V)	COIL RESISTANCE			MUST OPERATE VOLTAGE	MUST DROPOUT VOLTAGE	MAXIMUM VOLTAGE	POWER
	FRM5-F	FRM5-T	FRM5N	% OF RATED VOLTAGE (At +20 °C)			CONSUMPTION
AC	6	4.4	5.5	80 Max.	30 Min.	120 Max.	FRM5 : 2.5VA Approx.  FRM5N 2.7VA Approx.
	12	20	24				
	24	80	93				
	110	1860*	1600*				
	220	7400*	7400*				
	240	-	-				
DC	6	23.5	40	80 Max.	15 Min.		1.5W (FRM5-F) 1.2W (FRM5-T) 1.5W (FRM5N)
	12	95	150				
	24	430	570				
	48	1630*	2230*				
	110	7300	10080*				

Note : "\*" Respresent resistance error is +/- 15%.

### CHARACTERISTICS

Contact Arrangement	DPDT(2 Form C), 3PDT(3 Form C)
Contact Material	Ag Alloy
Contact Resistance	50mΩ Max.
Contact Rating (Resistive Load)	FRM5 : 10A 28VDC /220VAC FRM5N : 10A 28VDC /250VAC Inductive load : 7A 250VAC COSφ : 0.4
Contact Voltage Drop	Less than 200mV (Normal value) Less than 500mV (Max. value)
Operate Time (Initial)	AC : 20ms Max. DC : 30ms Max.
Release Time (Initial)	20ms Max.
Insulation Resistance	100MΩ Min.
Dielectric Strength	1000V AC (50Hz/min.) Between open contacts 1500V AC (50Hz/min.) Between coil and contact For FRM5N : 2500VAC (50Hz/min.) Between Coil and contact
Shock Resistance	Malfunction : 100m/s <sup>2</sup> Mechanical : 1000 m/s <sup>2</sup>
Vibration Resistance	1.5mm double amplitude, 10-50Hz
Ambient Temperature	-10°C to +40°C
Humidity	30 ~ 85% RH
Operation Life	Mechanical : 10 <sup>7</sup> Electrical : FRM5 - 10 <sup>5</sup> (At rated load); FRM5N - 5 x 10 <sup>5</sup> (At rated load)
Weight	FRM5 : 125g Approx. FRM5N : 85g Approx.

[Specifications are subject to change without notices.]

### FORWARD INDUSTRIAL COMPANY. (O/B COMMERCIAL UNION LTD)

RM. 1405, Wu Sang House, 655 Nathan Road, Mongkok, Kowloon, Hong Kong.

TEL : (852) 27892365 FAX : (852) 27893102 E-MAIL : sales@ficrelay.com.hk

WEBSITE : <http://www.ficrelay.com.hk>

# FRM5 RELAY



## ORDERING INFORMATION

FRM5 - T 3 L I DC12V

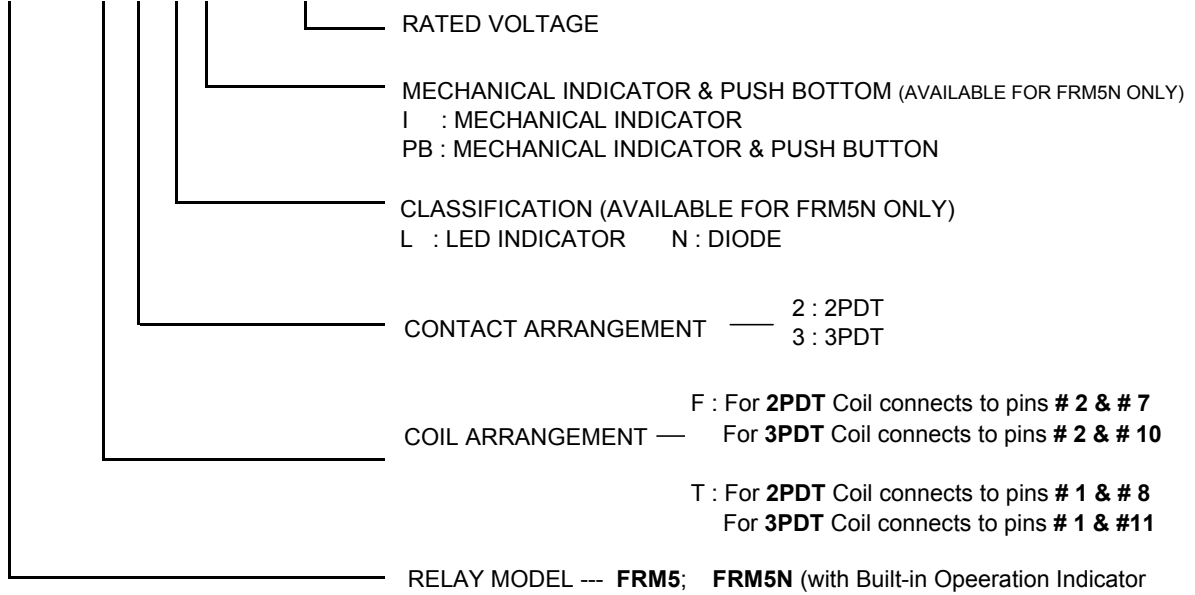

**Note : Pb-Free relay is available. (RoHS compliant relay is not available for FRM5.)**  
 For ordering, please add suffix "Pb-Free" to standard relay part numbers.

For example : FRM5-T2 DC 12V "Pb-Free" for Pb-Free Relay

## DIMENSIONS (UNIT: mm)

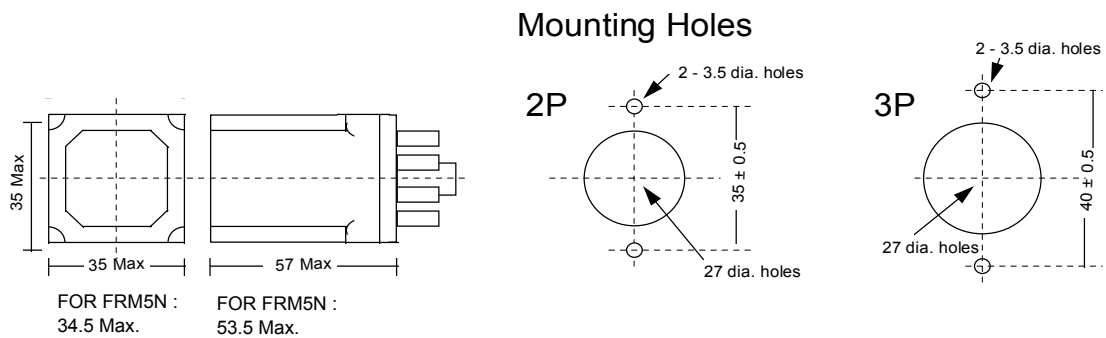

### Terminal Arrangement

FRM5/ FRM5N-F/2P

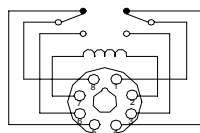

FRM5/ FRM5N-T/2P

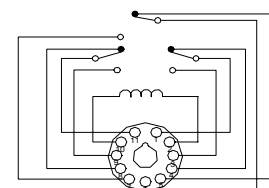
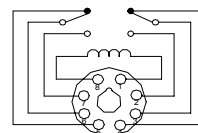

FRM5/ FRM5N-F/3P

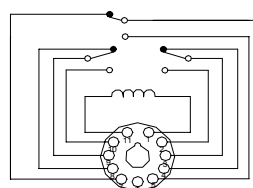

FRM5/ FRM5N-T/3P